

RESTWELL
SLEEP PRODUCTS

PLATEAU

Owner's Manual

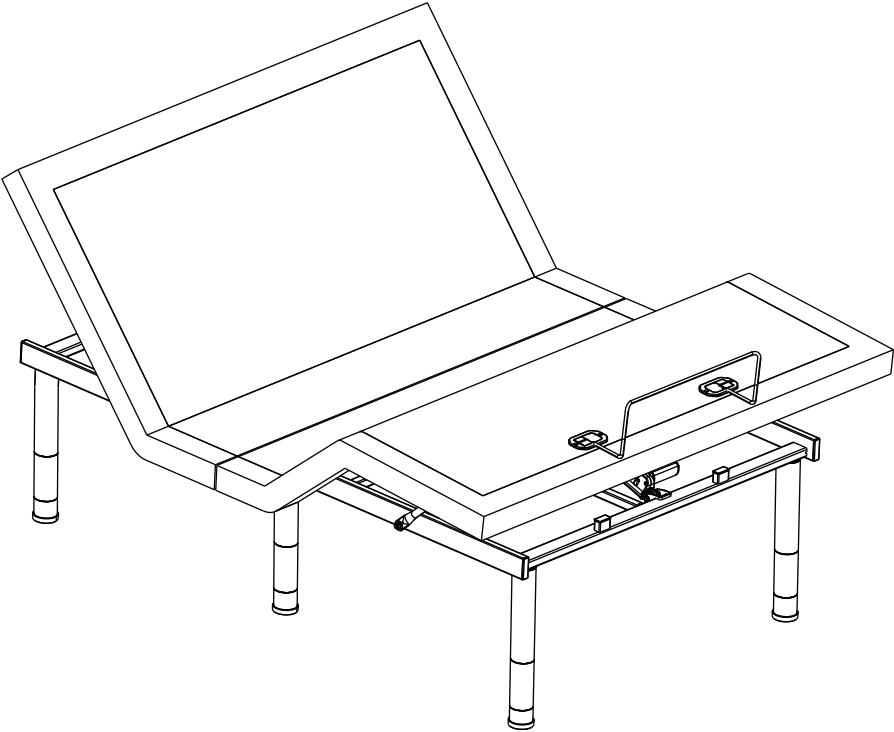

Serial No:
All Rights Reserved.

Rev 1.0
40034321

RESTWELL
SLEEP PRODUCTS

CONTENTS

Safety & Warranty Warning.....01

Parts List02

Installation Guide.....03

Remote Control Guide.....08

APP Control Guide.....09

Troubleshooting.....10

ATTENTION!

Important safety instructions. Please read these instructions thoroughly before using this product.

IMPORTANT SAFETY INSTRUCTIONS

When using an electrical furnishing, basic precautions should always be followed, including the following:
Read all instructions before using (this furnishing).

DANGER – To reduce the risk of electric shock

1. Always unplug this furnishing from the electrical outlet before cleaning or servicing

WARNING – To reduce the risk of burns, fire, electric shock, or injury to persons:

1. Unplug from outlet before putting on or taking off parts.
2. Close supervision is necessary when this furnishing is used by, or near children, invalids, or disabled persons.
3. Use this furnishing only for its intended use as described in these instructions. Do not use attachments not recommended by the manufacturer.
4. Never operate this furnishing if it has a damaged cord or plug, if it is not working properly, if it has been dropped or damaged, or dropped into water. Return the furnishing to a service center for examination and repair.
5. Keep the cord away from heated surfaces.
6. Do not use bed outdoors.
7. Do not use bed near explosives.
8. Using bed with oxygen administering equipment other than the nasal masked type creates a possible fire hazard.
9. Do not operate where aerosol (spray) products are being used or where oxygen is being administered.
10. To disconnect, turn all controls to the off position, then remove plug from outlet.
11. Use caution when having liquids in or around the bed to ensure no spillage occurs. In case of spillage, stand in a dry, clean area of the floor and unplug the bed immediately. Clean up spill and allow the area around bed to dry thoroughly before using the electric controls again. Do not eat or drink hot liquids while operating the bed.
12. Do not allow any person or pet under the bed at any time.
13. During bed operation, make sure body is positioned within the confines of the bed. Do not place extremities over the sides of the bed when operating bed functions.
14. Only for household and similar location use.

15. Never operate the furnishing with the air openings blocked. Keep the air openings free of lint, hair, and the like.
16. Never drop or insert any object into any opening.

SAVE THESE INSTRUCTIONS

WEIGHT LIMITS:

- Weight Restrictions: The recommended weight limits on our adjustable beds is 700 pounds. The bed will structurally support this weight, provided it is evenly distributed across the foundation. The power foundation is not designed to support or lift this amount in the head or foot sections alone. Exceeding this weight restriction could damage the bed and/or cause injury and will void the warranty.

WARRANTY WARNINGS:

- Any opening or tampering with the control box, motors, or hand controls (with the exception of the battery compartment if equipped) will result in a void of the warranty.

PRODUCT RATING:

- The motors are not designed to operate continuously for more than [2] minutes in an [20] minute time period or approximately 10% duty cycle. Attempting to circumvent or exceed this rating will shorten the life expectancy of the foundation and may void the warranty.

OPERATING INFORMATION:

- After power foundation assembly is completed, operate remote control to ensure proper functions.
- Keep moving parts free of obstruction during bed operation (including sheets, clothing, tubing, wiring, and products using electric power cords).
- Distribute body weight evenly over bed surface. Do not place entire weight on head or foot sections of the bed, during repositioning and entering or exiting bed.

HOSPITAL DISCLAIMER:

- It is NOT designed for hospital use and is NOT designed to meet hospital standards.

RADIO FREQUENCY: 2.4 GHz

FCC COMPLIANCE:

This device complies with Part 15 of the FCC Rules. Operation is subject to the following two conditions: (1) This device may not cause harmful interference, and (2) this device must accept any interference received, including interference that may cause undesired operation.

To comply with the FCC RF exposure requirements, no change to the antenna or the device is permitted. Any change to the antenna or the device could result in the device exceeding the RF exposure requirement and void user's right to operate the device.



Standard Parts List



All electronics and components that need to be installed are placed in boxes under the foundation or attached to the frame. Before discarding the packing materials, ensure that all the parts are accounted for.

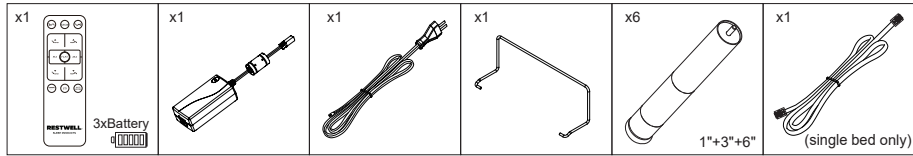

Wireless Remote

Power Supply
(29V 2.0A)

AC Power Cord

Mattress Retainer Bar

Adjustable Legs

Sync Cord

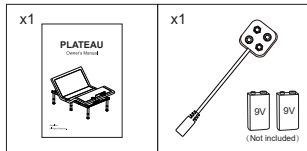

Owner's Manual

Battery Lock Wire

Optional Accessories (universal parts)

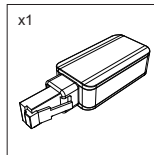

Bluetooth Receiver

Optional Accessories (headboard bracket)

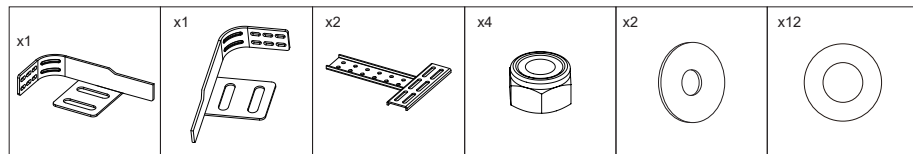

Headboard Bracket
Mount(L)

Headboard Bracket
Mount(R)

T-channel Assy

M8 Lock Nuts

Washers
(d10D30t2)

Washers
(d8.5D17t1.2)

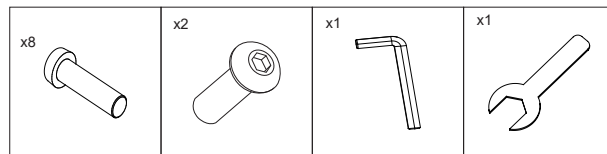

Hex Head Bolts
(M8x20)

Hex Socket Button Head
Screws(M10x25)

Socket Screw Wrench
(6#)

Simple Open End
Wrench S13

NOTE: To avoid damage to the foundation, always open the carton while the foundation is in the flat position.

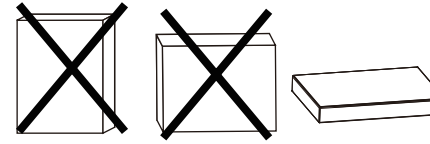

Installation Guide

Two people are required to set up the foundation.

1.

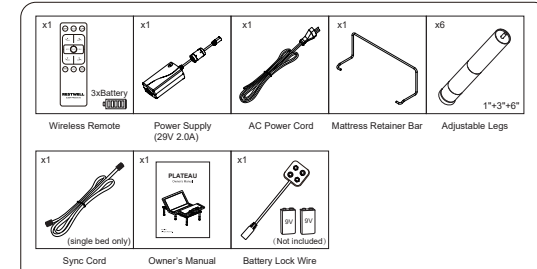
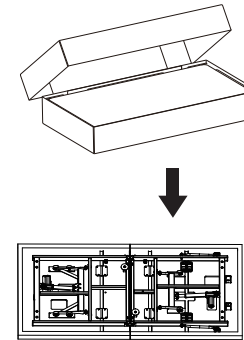

Open the box, take out all the packing components.

2.

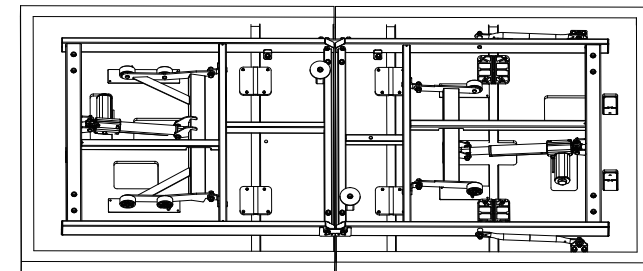

Remove the foundation from the box. Make sure the floor is clean. Flat the foundation.

3. If the adjustable legs are required, please refer to below installation guide.

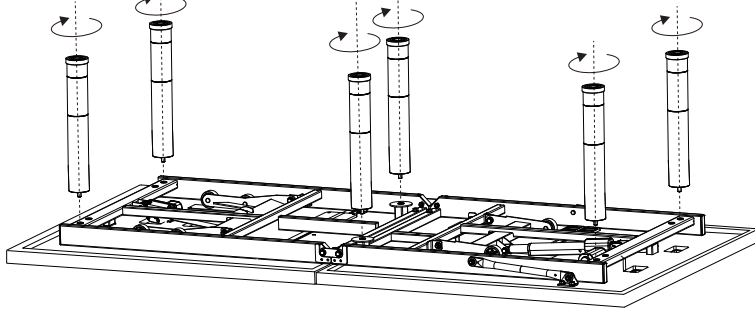

Install legs and tighten by hand.

4.

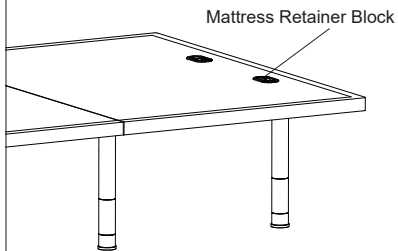

Carefully rotate the foundation over so it is resting on its legs.

5.

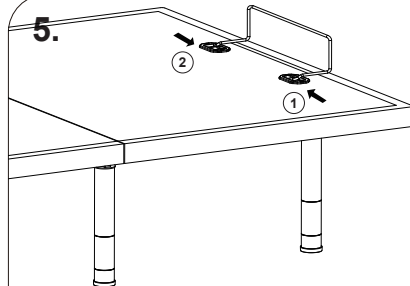

Slide the left side of the mattress retainer bar into the block. Pull the retainer bar to the opposite bracket and secure the right side.

6. Connect the DC power cord to the power supply, uncoil the AC power cord and then connect it to the AC power source .

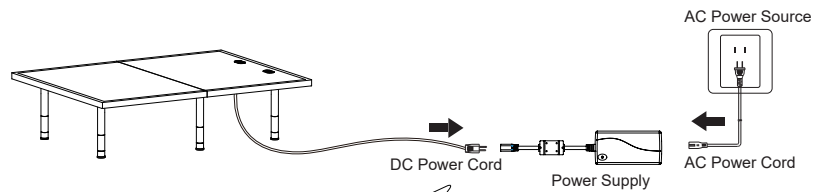

Connect the connectors as illustrated.

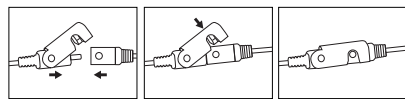

7. Insert batteries into the wireless remote.

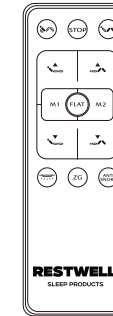
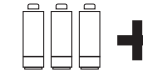

DONE!

Installation Guide (headboard bracket)

1.

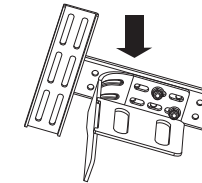
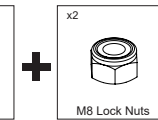
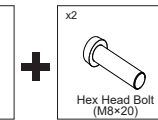
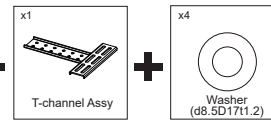
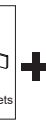
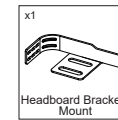

Install headboard brackets with socket screw wrench and simple open end wrench.

2.

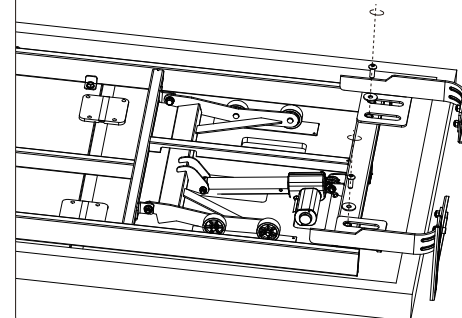

Install the assembled headboard brackets with washer(d10D30t2) and hex socket button head screws(M10x25) onto the end of head frame.

Electronics Quick Reference Guide

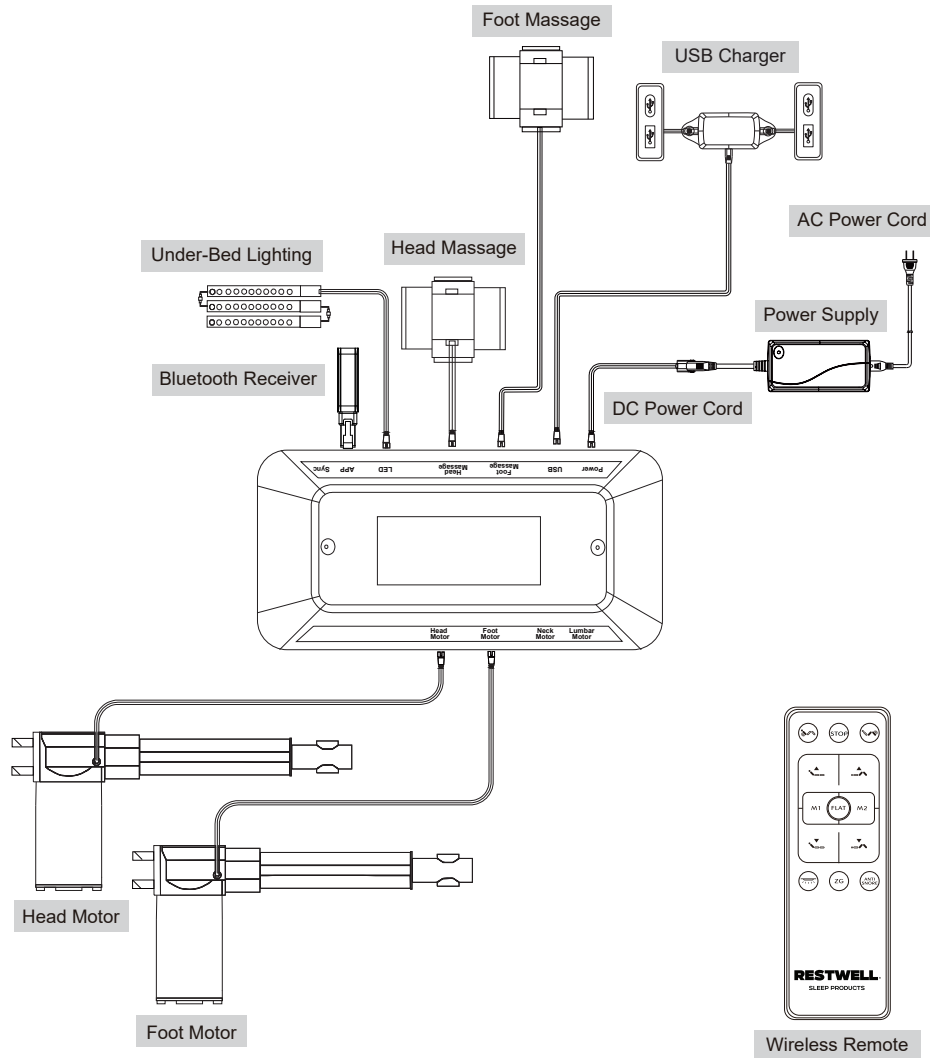

Synchronizing Two Foundations

If simultaneous operation of two foundations is desired, use the sync cord to connect the electronics of both foundations together. **(single bed only)**

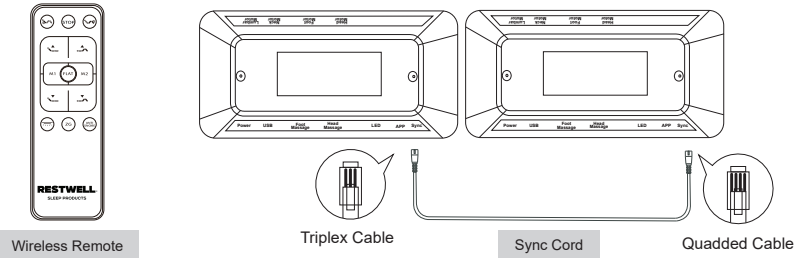

- STEP 1: Unplug foundations from the power source.
- STEP 2: Connect the male ends of the sync cord to the female sync plugs of the control boxes (Refer to illustration above).
- STEP 3: Plug foundations back into the power source.
- STEP 4: Press and hold and button, a beep sound of the buzzer will be heard and the backlit light of the wireless remote flashes twice. Open the battery box and toggle the switch to "P" position (in the middle of "A" and "B") first, next press and hold "FLAT" until you hear a beep sound of each buzzer on the control box, which means the two foundations can be synchronized with one remote.
- STEP 5: Open the battery box and toggle the switch to "A" or "B" position, you can control the two foundations separately without removing the sync cord.

Attention: (1) If you want to toggle from "A" or "B" to "P" position (in the middle of "A" and "B") to realize sync control, please press and hold "Flat" again until to a flat position. (2) The interval must more than 4s between plug in and plug out the sync cord.

Remote Pairing

The original remote that comes in the box is already paired to the foundation. Just wait 30s after the foundation is powered on, then the remote can be used normally. In the event that the remote is not paired with the foundation, follow the steps below.

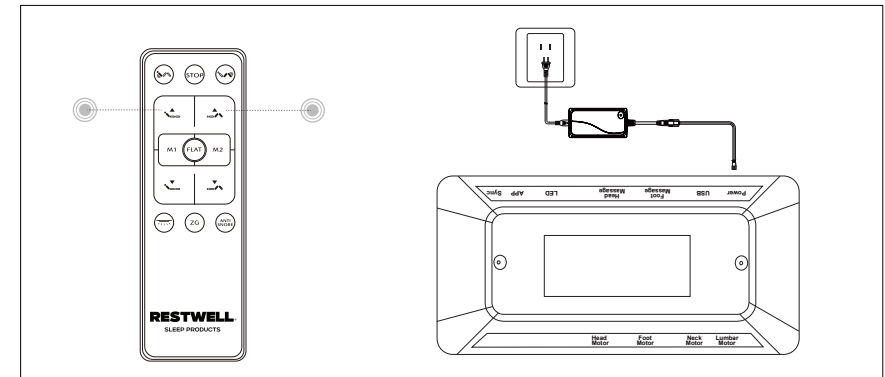

1. Unplug the foundation from the power source, wait 60s, then power it on.
2. Press and hold at the same time.
3. You will hear a beep sound of the buzzer and the backlit light of the wireless remote flashes two times, which means the pairing is successful.

NOTE: Please complete the repairing within 30s after the foundation is powered on.

Remote Control Guide

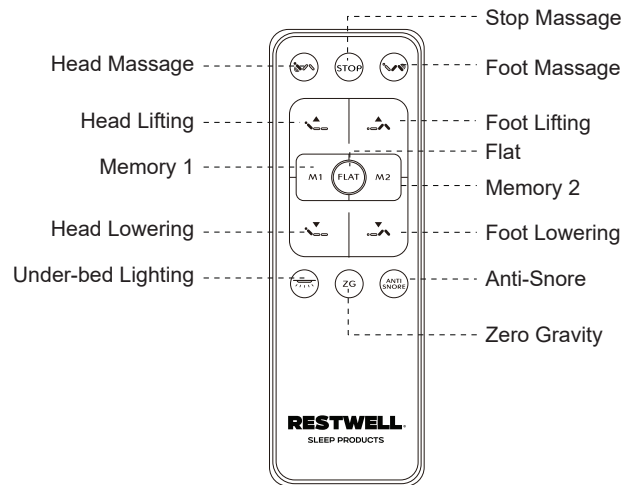

Adjustment



One Touch Button

- M1 M2**: Press to adjust the base to "Memory 1" or "Memory 2".
STEP 1: Operate the remote to your desired position.
STEP 2: Press and hold "M1" or "M2" for more than 3s till hearing a beep sound of the buzzer on the control box and the backlit light of the wireless remote flashes two times, which means the memory position is saved.
- Massage**: Press to turn on the Head/Foot Massage.
Press the button once to increase one intensity level, there are 3 intensity levels available. When it has been in the 3rd level, press the button again and the massage will off. The massage motor will be off automatically after 30min.
- STOP**: Press to turn off both the head and foot massage together.
- ZG**: Press to elevate the foot section slightly higher than the chest, in effect, allowing the blood to flow back to the heart to help reduce stress and fatigue.
- FLAT**: Press to adjust the foundation to the flat position.
- Lighting**: Press to turn on the under-bed lighting. The light will be off if the button is not pressed within 10min.
- ANTI SNORE**: Press "ANTI SNORE" to adjust the foundation to the pre-programmed anti-snore position that keeps you getting a restful night.

Battery Lock Wire Installation Guide

When disconnect the power supply, the battery lock wire and two batteries with 9V 2A can be used together to flat the foundation.

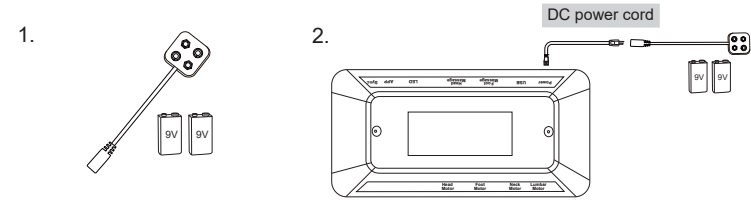

How To Reset

- STEP 1: Unplug foundations from the power source.
- STEP 2: Plug foundations back into the power source after 60 seconds.
- STEP 3: Automatic reset is completed.

Dream Motion APP (optional)

The Dream Motion APP is applied to control the foundation, available to both IOS and Android users.

Before using the APP, you need to connect the Bluetooth to the APP port in the control box.

IOS

Open the APP store, search the keyword "Dream Motion" to download the application. Dream Motion

Android

Open the Google Play to search the keyword "Dream Motion" and download the application. Dream Motion

Please follow the operation guidance in APP!

Troubleshooting

In the event the adjustable foundation fails to operate, investigate the symptoms and possible solutions below.

<p>The adjustable foundation does not respond when the remote is used. Remote control appears to be normal.</p>	<ul style="list-style-type: none"> • Make sure the remote control is paired with the foundation. • Check that the power cord is plugged into a working and grounded electrical outlet. Unplug the power cord from the outlet. After 60 seconds, plug it back in. Press any button on the remote control and hold until backlit light on the wireless remote illuminates.
<p>No features or function of the foundation activates.</p>	<ul style="list-style-type: none"> • Make sure the wireless remote is paired with the foundation. • Check that the power cord is plugged into a working and grounded electrical outlet. Unplug the power cord from the outlet. After 60 seconds, plug it back in. Press any button on the wireless remote and hold until backlit light on the wireless remote illuminates. • Check that the surge protection device or electrical outlet is not defective. Test the outlet by plugging in another working appliance.
<p>Head or foot lifts elevate foundation but does not return to flat position.</p>	<ul style="list-style-type: none"> • Your foundation may be obstructed preventing smooth operation. Remove obstructions from around and under the bed. • Check that the head section is not too close to the wall. • If a headboard is installed, check that it is not too close to the edge of the mattress. Make sure there is enough distance between the headboard bracket and the mattress.
<p>Head or foot lift function has minor interference during operation.</p>	<ul style="list-style-type: none"> • Check the batteries in the wireless remote. Replace with new batteries, if necessary. • Make sure that you are following the duty cycle of the motors. Do not operate for more than two minutes over a 20-minute period or approximately 10% duty cycle. • Press the lift buttons firmly and accurately. • Wireless remote control may be experiencing common radio frequency interference from other radio transmitting devices. Wait several seconds and then try pressing the lift buttons again.
<p>A clicking noise is heard under the foundation when raising or lowering the sections.</p>	<ul style="list-style-type: none"> • This is normal. The lift motors click when they are engaged. No action is required.
<p>Excessive massage motor noise.</p>	<ul style="list-style-type: none"> • If the foundation is located on hard surface flooring, place carpet pieces or rubber pieces (not included) under each leg. • Using the wireless remote control, elevate the head, foot or neck section a short distance to realign the lift/lower mechanisms with the foundation support platform. • Verify that your foundation is not positioned against a wall, nightstand, or other object that may cause the vibration or noise. • If the foundation is installed over a foundation frame, verify that the massage motors are not causing the foundation frame (or foundation frame components) to vibrate. • Verify that the headboard attachment hardware is properly tightened (if used).